

SS166R SAFARI R-SPEC SNORKEL

Holden Colorado with
3.0 litre 4JJ1 VCDi Turbo Diesel engine



01/04/2015

Parts List

ITEM	PART NO	DESCRIPTION	QTY
1	725-133-000R	BODY - SNORKEL	1
2	000-135-800	3 ½" AIR RAM ASSEMBLY	1
3	000-441-200	SLEEVE - AIR RAM	1
4	725-032-000	BRACKET - UPPER MOUNTING S/STEEL	1
5	000-002-100	BOLT - HEX - 6mm x 1.0 x 14mm	2
6	000-958-350	POP RIVET - 4.8mm x 14mm	3
7	000-110	STUD - 8mm x 1.25 x 26mm	6
8	000-311-300	WASHER - BODY - 8.5mm x 32mm	6
9	000-205-300	NUT - NYLOC - M8 x 1.25	6
10	725-024-000	HOSE - AIR ENTRY	1
11	000-909	CLAMP - HOSE - 80/100mm	2
12	000-914/B	CLAMP - AIR RAM - SIZE 56 (BLACK)	1
13	725-017-000	TEMPLATE	1

Installation Guide

Fitment to:

- Right Hand Side

Fitting Time:

- 120min

Special Tools:

- 95mm hole saw
- step drill
- pop rivet gun
- scribe
- touch-up paint
- prep-wash
- masking tape
- Sikaflex 227 Adhesive Sealant
- Loctite 243 Threadlocker
- Loctite 406 Instant Adhesive

Prior to commencing the installation, it is the installer's responsibility to verify that all components and particularly the template (Item 13) are correct.

NB: The SS166HF snorkel system has not been tested on vehicles fitted with an automatic transmission.

1

Disconnect the battery and remove the engine control unit (ECU). Cover the ECU plugs to prevent foreign particles from entering the ECU plugs and sockets.

ECU Plugs



2

Remove the following in accordance with the factory service manual.

- RHS inner guard liner
- Air cleaner assembly
- RHS flare (if fitted to vehicle)

3

Remove and discard the air entry duct from the inner guard.

Remove and Discard



4

Tape the template (Item 13) to the rear and upper edges of the RHS guard panel.

With the template correctly positioned, mark all of the hole positions with a felt tip pen.

Remove the template.

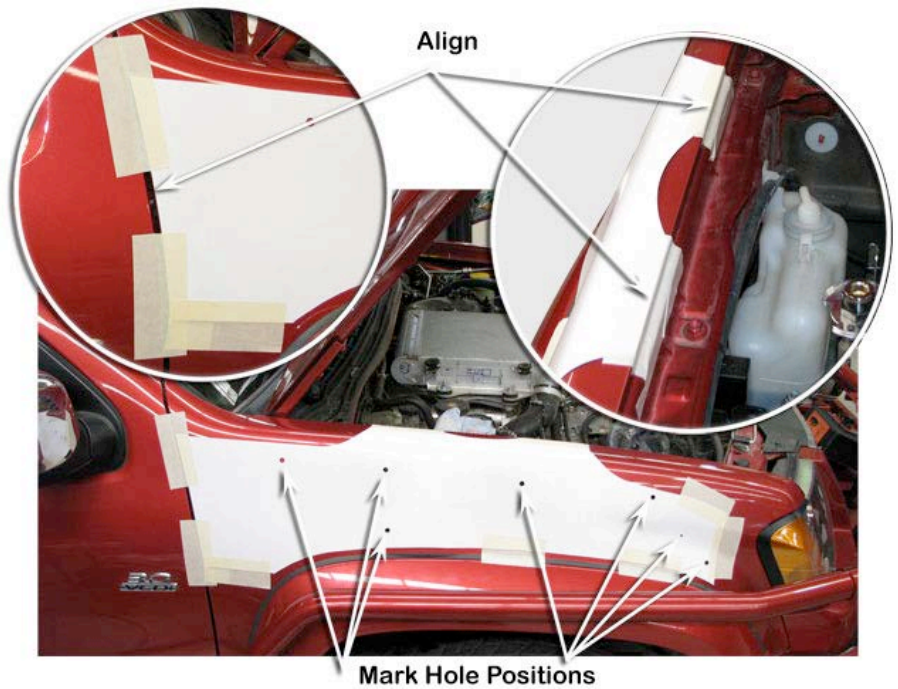

5

Drill a pilot hole for each marked hole position.

Use a step drill to drill the six mounting holes to 16mm diameter.

Drill the snorkel body outlet hole with a 95mm diameter hole saw.

Deburr and paint holes to prevent rust.

Drill 16mm Diameter

Drill 95mm Diameter

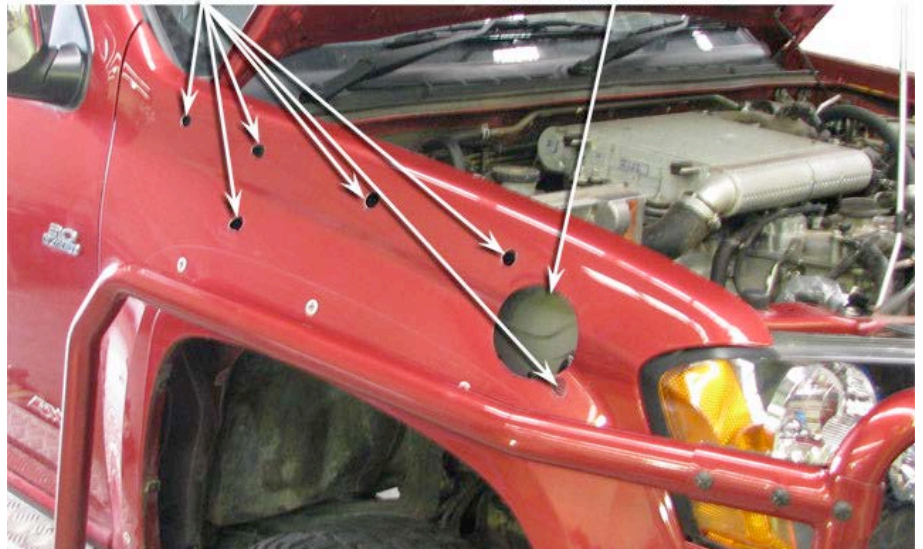

6

Install the upper mounting bracket (Item 4) to the snorkel body (Item 1) with hex bolts (Item 5),

Apply Loctite to each of the mounting studs (Item 7) and install the studs finger tight into the snorkel body mounting inserts.

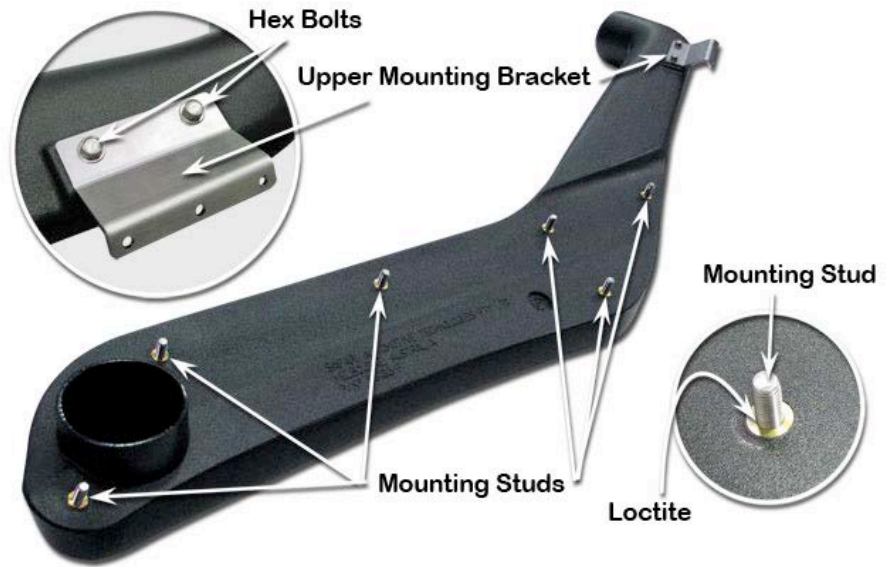

7

Measure 65mm down from the top of the snorkel body and mark the circumference.

Slide the air ram sleeve (Item 3) over the top of the snorkel body (Item 1) and align the bottom of the sleeve with the 65mm mark.

Lift the edges of the sleeve (Item 3) and apply several small dabs of Loctite 406 Instant Adhesive or similar to secure the sleeve in position.

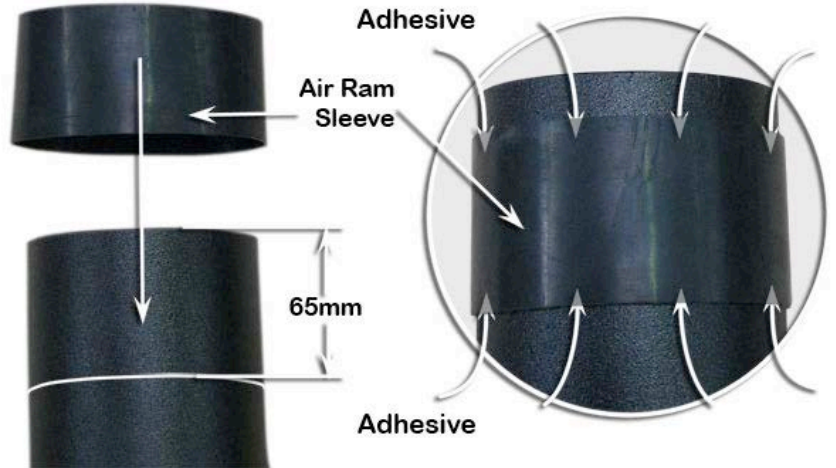

8

Detach the A-Pillar section of the rubber weather seal moulding.

With the RHS front door open, carefully place the snorkel body (Item 1) onto the guard panel.

With the snorkel body correctly positioned, push the upper mounting bracket up against the windscreen trim and mark the three upper mounting bracket hole positions with a scribe.



- 9** Remove the snorkel body (Item 1) from the guard panel and remove the upper mounting bracket (Item 3) from the snorkel body.

Drill a pilot hole in the centre of each marked hole position and then drill to 5mm diameter.

Debur and paint holes.

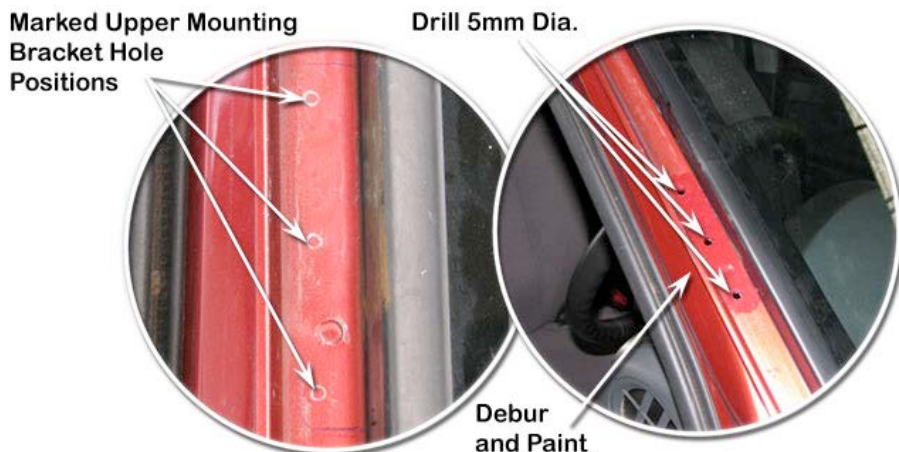

- 10** Apply a small amount of Sikaflex sealant to the underside of the upper mounting bracket (Item 3) and install the upper mounting bracket to the A-pillar with three pop-rivets (Item 6).

Clean up excess sealant and then refit the rubber weather seal moulding to the A-pillar ensuring that the moulding clips back into the channel correctly.



- 11** Remove the pre-spinner assembly from the air cleaner housing base.

Remove and discard the pre-spinner inlet.

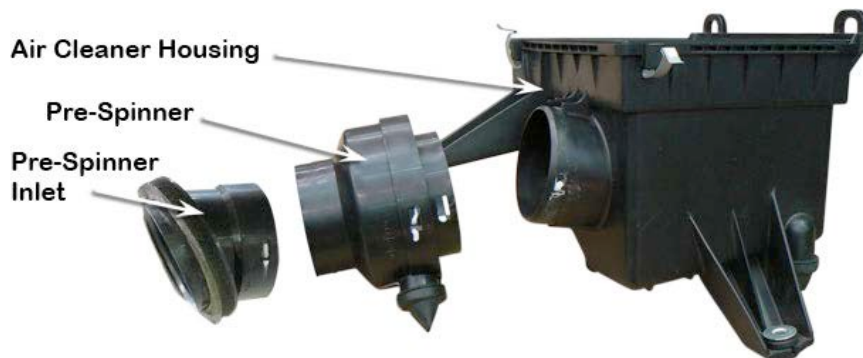

- 12** Use a die grinder or coarse file to remove the retaining lugs from the pre-spinner snout as shown.

Unclip and disassemble the pre-spinner assembly. Apply adhesive sealant to the mating surfaces in order to make the connection water-proof.

Reassemble the pre-spinner and wipe away any excess sealant.

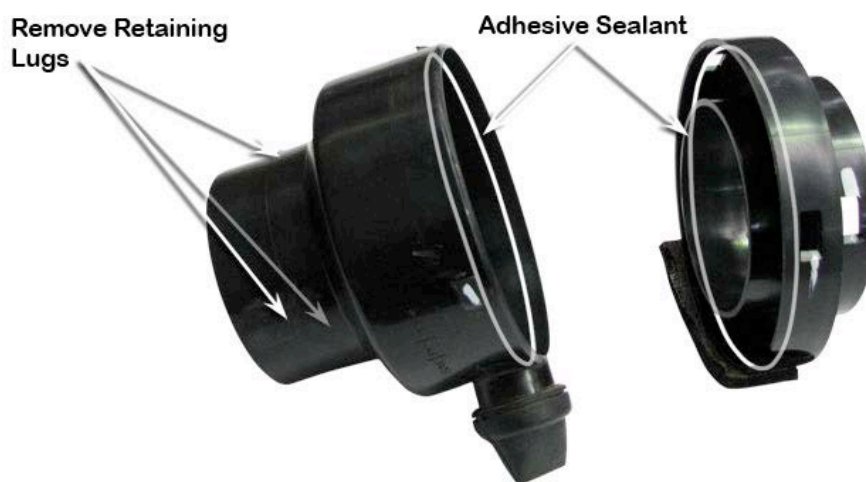

13

Apply adhesive sealant to the mating surfaces of the air cleaner housing inlet and the pre-spinner.

Install the pre-spinner to the air cleaner housing.



Installer's Option

The air cleaner housing base/underside and the pre-spinner have drain openings that may permit water to enter the air intake.

It is up to the installer to decide whether they should be sealed.

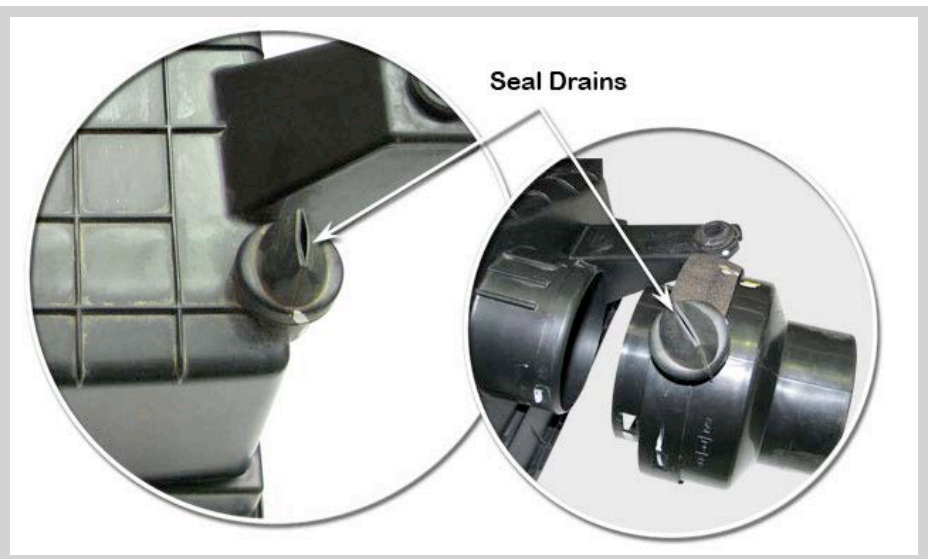

14

Working from inside the wheel arch area, install the air entry hose (Item 10) through the standard hole in the inner guard panel.

Install an 80/100mm hose clamp (Item 11) loosely at each end of the air entry hose.



- 15** Rotate the air entry hose (Item 10) so that the other end is aligned with the 95mm hole previously drilled into the guard panel.

Lightly lubricate the inside surface of the air entry hose (Item 10) and Install the air cleaner assembly whilst guiding the pre-spinner snout into the air entry hose (do not tighten the hose clamp (Item 11) until instructed in step 17).

Use the standard mounting hardware to secure the air cleaner housing.

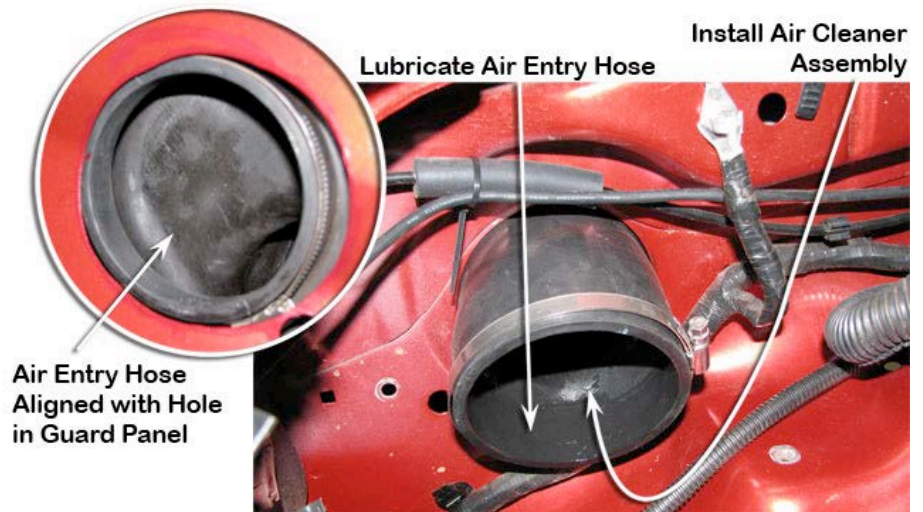

- 16** Install the snorkel body (Item 1) to the guard panel whilst guiding the snorkel body outlet into the air entry hose (Item 10).

Fasten the snorkel body (Item 1) to the guard panel with body washers (Item 8) and Nyloc nuts (Item 9).

Fasten the snorkel body (Item 1) to the upper mounting bracket (Item 4) with two 6mm hex bolts (Item 5).

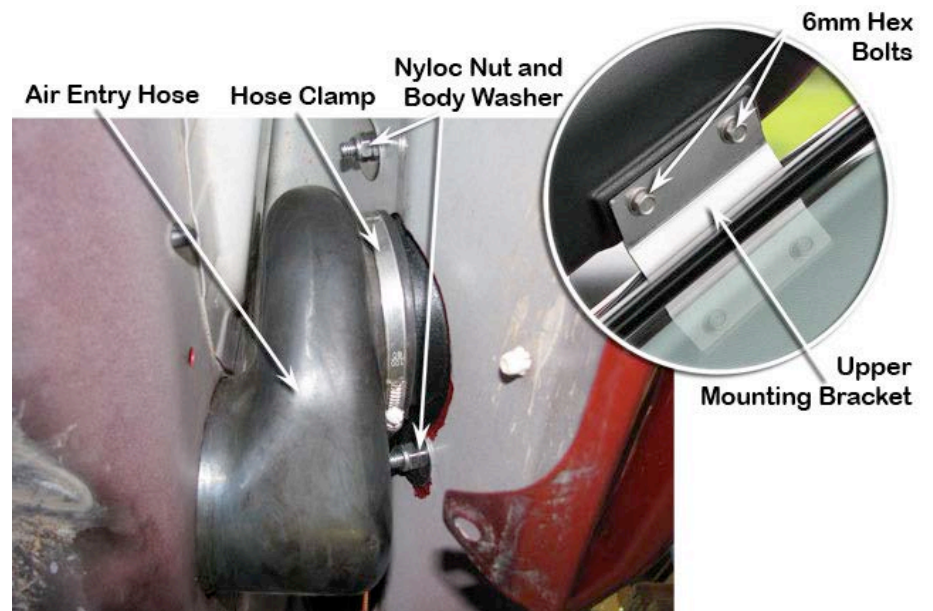

- 17** Align the air entry hose (Item 10) for best fit and adequate clearance as shown.

Tighten the hose clamp (Item 11) at the snorkel body end of the air entry hose. Then tighten the hose clamp (Item 11) at the air cleaner assembly end of the air entry hose (Item 10).

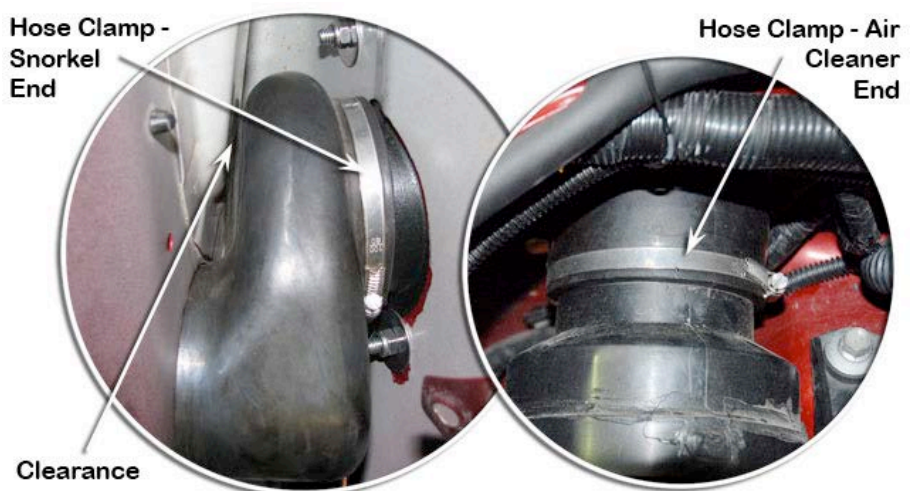

18

Install the ECU and with great care, install the ECU plugs into their respective sockets.

Reinstall the air filter element, air cleaner housing top and connect the air mass sensor plug.

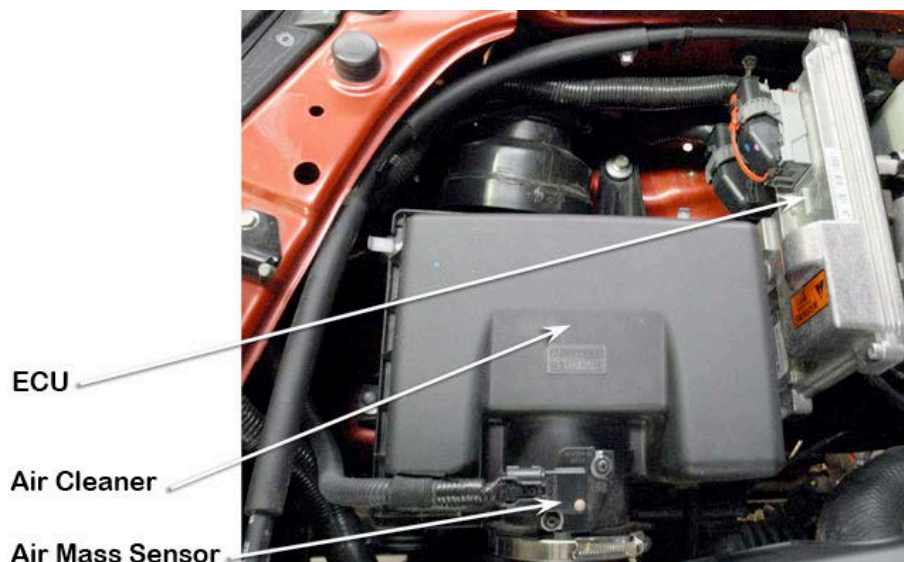

19

Loosely install the black hose clamp (Item 12) to the base of the air ram assembly (Item 2). Install the Air ram assembly onto the snorkel body.

Align the air ram assembly and tighten the black hose clamp (Item 12).



20 Reconnect the battery terminals, reinstall the guard liner, flare (if fitted to vehicle) and any other components that may have been removed.

NB It is the installer's responsibility to ensure all connections are watertight.